

2D REFERENCE SIZE(UNIT:mm)

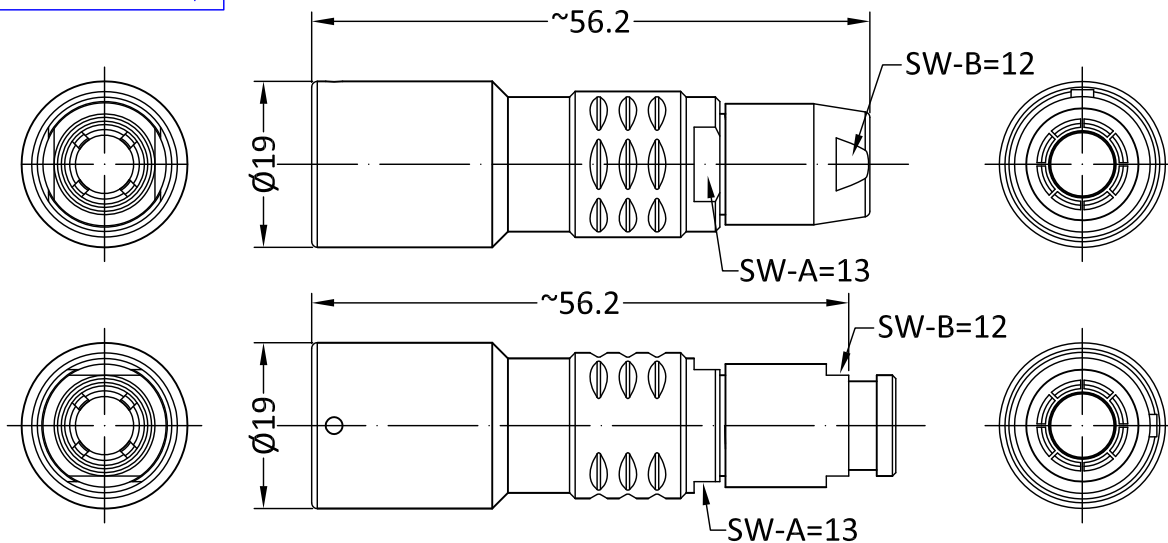

- Housing Material: Brass pearled chrome
- Insulator Material: PPS
- Contact Material: Copper alloy
- Mating cycle: 5000 times(IEC 60512 test 9a)
- IP Rating: IP68。 (IEC 60529)
- Humidity (max): <=95%[at 60℃]
- Temp (min/max): -55℃~+125℃(GB/T2423.3)
- Vibration: 10-2000Hz, 15g(IEC 60512-4 test 6d)
- Shock Resistance: 100g, 6ms(IEC 60512-4 test 6c)
- Salt Spray Corrosion: >96h(IEC 60512-6 test 11f)



Images is for illustrative purpose only

### PART NUMBERING SYSTEM:

FREE SOCKET

MODEL

KEY:  
G=0°; A=30°;  
B=60°; C=90°; ...

SERIES

CONTACTS:3=MULTICORE;  
16=16PINS (2~16PINS OPTIONAL)

HOUSING:  
C=BRASS PEARLED CHROME;  
K=BRASS PLATED BLACK CHROME;  
T=ALUMINIUM ALLOY PLATED NICKEL

INSULATOR:  
P=PPS;K=PEEK;

SHG.2K326.CPAC.\*\*\*

VARIABLE PARAMETER:  
M=OVERMOLDING;  
EMPTY=COLLET NUT  
WITHOUT BEND RELIEF  
COLOR FOR BEND RELIEF:  
G=GREY;B=BLUE;W=WHITE;  
L=BLACK;R=RED;Y=YELLOW;  
M=BROWN;O=ORANGE;V=GREEN

CABLE:  
42=(CABLEØ3.2mm-4.2mm);  
52=(CABLEØ4.1mm-5.2mm);  
65=(CABLEØ6.5mm-6.1mm);  
70=(CABLEØ7.0mm-6.6mm);  
85=(CABLEØ8.5mm-8.1mm);  
11=(CABLE10.5mm-10.1mm);

C: CABLE COLLET



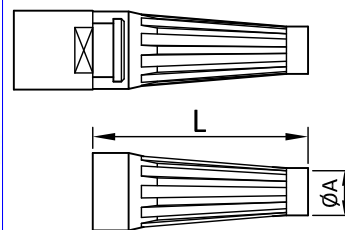

CONTACTS TYPE:  
A=MALE SOLDER ;L:FEMALE SOLDER;  
D=PCB-MALE ;N=PCB-FEMALE;V=PCB- FEMALE ELBOW

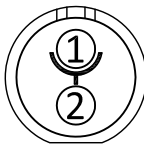
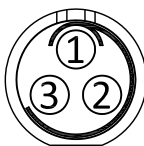

SIZE(mm)

BEND RELIEF	L	CABLEØ	
		Max	Min
A	36	5.1	4.2
5.0	36	6.1	5.2
6.0	36	7.0	6.2
7.0	36	8.2	7.2
8.0	36	9.5	8.3
9.5	36		

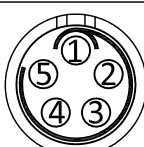
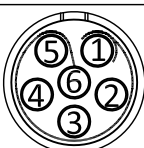
\*=Customers can choose the model according to their own needs

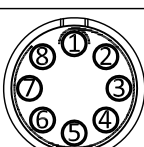
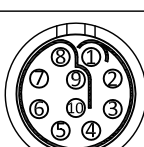
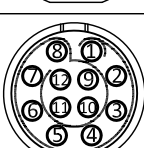
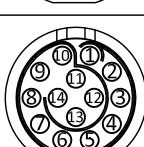
P/N	CORE	TYPE	PIN DIA (mm)	WORK VOLTAGE (KV rms)		RATED CURRENT (A)	CONTACT RESISTANCE (mΩ)	CABLE (AWG)	
				CONTACTS-CONTACTS	CONTACTS-SHELL			min.	max.
SHG.2K302.CPLC.***	2		2.0	2.10	1.75	25	5	18	12
SHG.2K303.CPLC.***	3		1.6	2.40	1.85	17	5	22	14
SHG.2K304.CPLC.***	4		1.3	1.85	1.85	15	6	26	18
SHG.2K305.CPLC.***	5		1.3	1.75	1.6	14	6	26	18
SHG.2K306.CPLC.***	6		1.3	1.35	1.45	12	7.5	26	18
SHG.2K307.CPLC.***	7		1.3	1.75	1.6	11	7.5	26	18
SHG.2K308.CPLC.***	8		0.9	1.5	1.25	10	7.5	32	20
SHG.2K310.CPLC.***	10		0.9	1.45	1.3	8	10	32	20
SHG.2K312.CPLC.***	12		0.7	1.25	1.35	7	10	32	22
SHG.2K314.CPLC.***	14		0.7	1.15	1.35	6.5	10	32	22

\*=Customers can choose the model according to their own needs

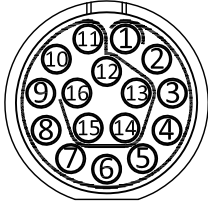
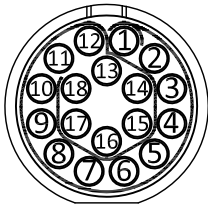
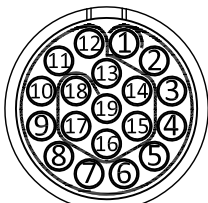
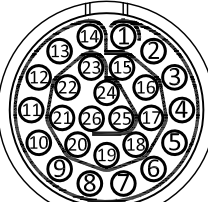
P/N	CORE	TYPE	PIN DIA (mm)	WORK VOLTAGE (KV rms)		RATED CURRENT (A)	CONTACT RESISTANCE (mΩ)	CABLE (AWG)	
				CONTACTS-CONTACTS	CONTACTS-SHELL			min.	max.
SHG.2K316.CPLC.***	16		0.7	0.95	1.25	6	10	32	22
SHG.2K318.CPLC.***	18		0.7	0.85	1.2	5.5	10	32	22
SHG.2K319.CPLC.***	19		0.7	0.95	1.25	5	10	32	22
SHG.2K326.CPLC.***	26		0.5	0.95	1.30	2	10	-	-

\*=Customers can choose the model according to their own needs