

2D REFERENCE SIZE(UNIT:mm)

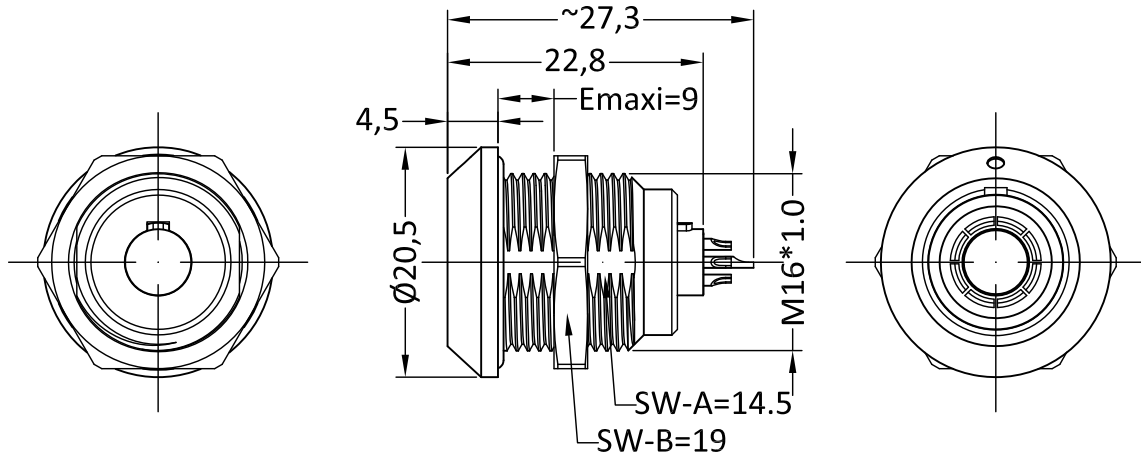

- Housing Material: Brass pearled chrome
- Insulator Material: PPS
- Contact Material: Copper alloy
- Mating cycle: 5000 times(IEC 60512 test 9a)
- IP Rating: IP68。(IEC 60529)
- Humidity (max): <=95%[at 60°C]
- Temp (min/max): -55°C~+125°C(GB/T2423.3)
- Vibration: 10-2000Hz, 15g(IEC 60512-4 test 6d)
- Shock Resistance: 100g, 6ms(IEC 60512-4 test 6c)
- Salt Spray Corrosion: >96h(IEC 60512-6 test 11f)

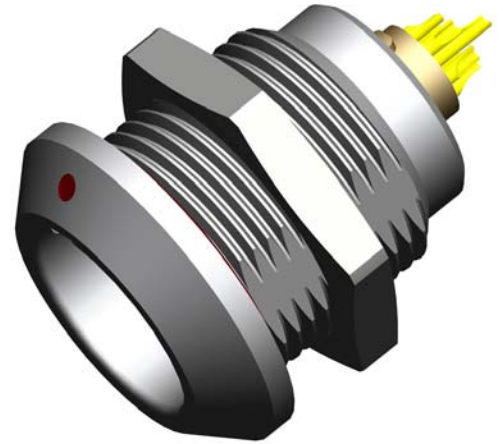

Images is for illustrative purpose only

PART NUMBERING SYSTEM:

FIXED SOCKET

SGG·1K316·CP*

MODEL

KEY:

G=0°; A=30°;
B=60°; C=90°; ...

SERIES

CONTACTS:3=MULTICORE;
16=16PINS (2~16PINS OPTIONAL)

HOUSING:

C=BRASS PEARLED CHROME;
K=BRASS PLATED BLACK CHROME;
T=ALUMINIUM ALLOY PLATED NICKEL





INSULATOR:

P=PPS;K=PEEK;

CONTACTS TYPE:

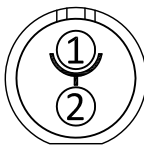
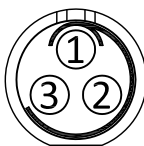
A=MALE SOLDER ;L:FEMALE SOLDER;
D=PCB-MALE ;N=PCB-FEMALE;
V=PCB- FEMALE ELBOW

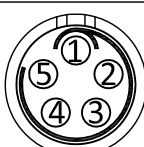
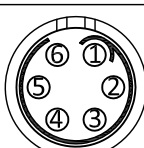
*=Customers can choose the model according to their own needs

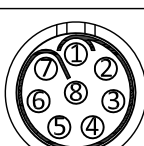
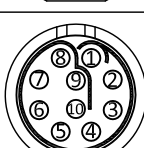
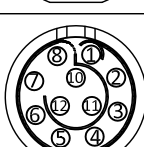
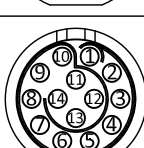
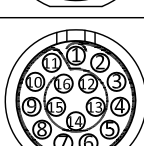
P/N	CORE	TYPE	PIN DIA (mm)	WORK VOLTAGE (KV rms)		RATED CURRENT (A)	CONTACT RESISTANCE (mΩ)	CABLE (AWG)	
				CONTACTS-CONTACTS	CONTACTS-SHELL			min.	max.
SGG.1K302.CP*	2		1.3	1.5	1.35	15	5	26	18
SGG.1K303.CP*	3		1.3	1.3	1.55	12	5	26	18
SGG.1K304.CP*	4		0.9	1.35	1.45	10	6	32	20
SGG.1K305.CP*	5		0.9	1.25	1.15	9	6	32	20
SGG.1K306.CP*	6		0.7	1.05	1.2	7	7.5	32	22
SGG.1K307.CP*	7		0.7	0.95	1.05	7	7.5	32	22
SGG.1K308.CP*	8		0.7	0.95	1.15	5	7.5	32	22
SGG.1K310.CP*	10		0.5	0.9	1.25	2.5	10	32	28
SGG.1K312.CP*	12		0.5	0.9	1.2	2.5	10	32	28
SGG.1K314.CP*	14		0.5	0.8	1.2	2	10	32	28
SGG.1K316.CP*	16		0.5	0.8	1.2	2	10	32	28

*=Customers can choose the model according to their own needs

NOTE: SOCKET WITH ELBOW(90°)CONTACT FOR PRINTED CIRCUIT, RATED CURRENT:6A

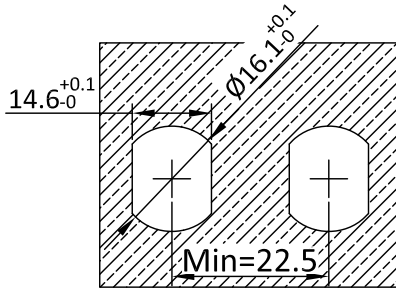

SERIES PANEL HOLES SIZE

PCB OPEN SIZE(STRAIGHT) PCB OPEN SIZE(ELBOW)

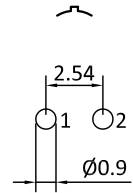
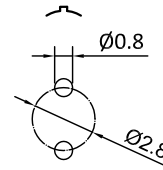

PCB OPEN SIZE(STRAIGHT)

PCB OPEN SIZE(ELBOW)

02

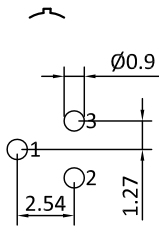
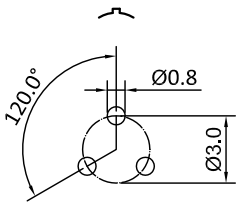

03

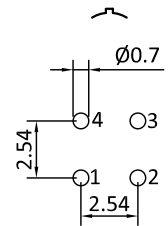
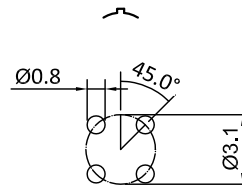

04

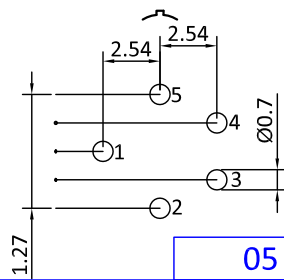
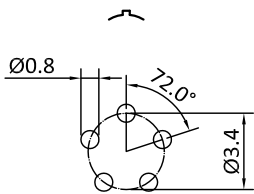

05

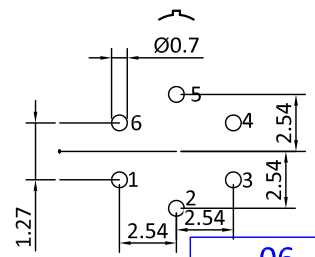
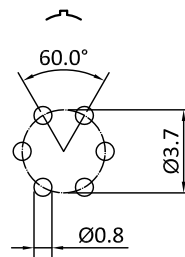

06

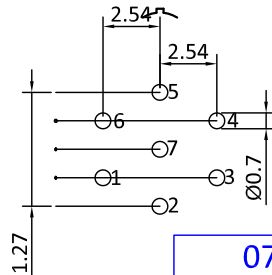
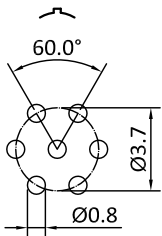

07

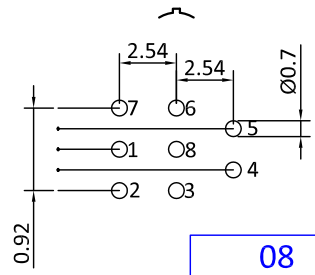
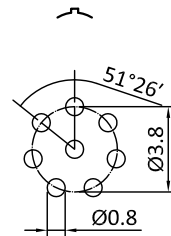

08

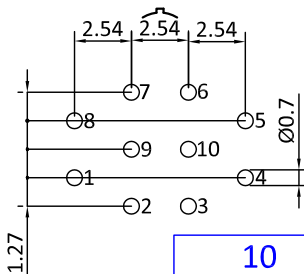
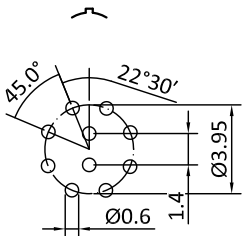

10

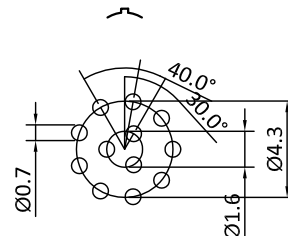

12

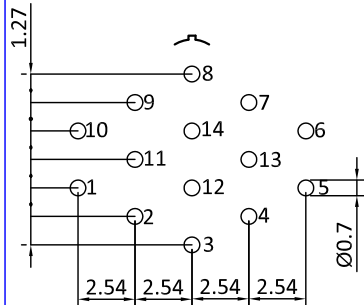
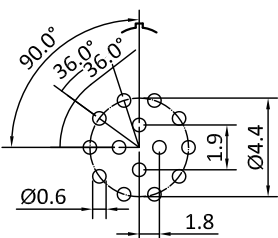

14

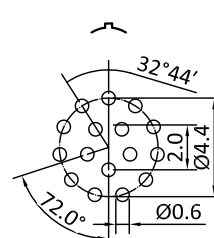

16